

AN EXPERIMENTAL INVESTIGATION INTO THE PARTICULATE EMISSIONS OF A FERRY FUELLED WITH ULTRA-LOW SULFUR DIESEL

Saliha Saadet Kalender and Selma Ergin

Key words: air pollution, emission measurements, exhaust emission, particulate matter, particle composition.

ABSTRACT

Ship-based emissions have the potential to adversely affect both the environment and human health. The particulate component of exhaust emissions is especially dangerous as it can cause cardiopulmonary disease and lung cancer as well as respiratory illnesses such as bronchitis, asthma and pneumonia depending on the size, shape and chemical activity of the particles. For this study, experiments were conducted to investigate the particulate emissions from a medium-speed diesel engine installed on a ferry. The experiments themselves were focused on the effects of ultra-low sulfur diesel fuel on the formation of particulate emissions. The measurements of particulate matter and gaseous emissions were carried out on-board a ferry operating in the Marmara Sea. The size distributions of particle mass were obtained for different engine loads and a particle size of PM_{2.5} was found to be the most widespread under all engine loads. In terms of shape, the particles were found to be generally spherical. The composition of the particles was investigated by using SEM/EDX analysis. The elemental analysis of the particles revealed that the samples contained 13 elements. Carbon was found to be the main component of diesel particles, and accounted for approximately 50-60% of the total emission composition. Concentrations of Fe and V were also found to be abundant, accounting for approximately 8% of the total emission composition. The study also presents the emission factors for particulate matter (PM), as well as NO_x, SO₂, CO, CO₂ and HC. The total of weighted PM emissions was found to be quite low at 0.079 g/kWh.

I. INTRODUCTION

Ship-based emissions have many adverse health and environ-

mental effects. The most important of these are their contributions to climate change, acidification and poor air quality. Ship-based emissions are, in many cases, a primary source of urban pollution in port cities. Moreover, emissions of NO_x, CO, VOCs, particles and sulfur etc. from ships at sea may be transported in the atmosphere over several hundreds of kilometers, thereby contributing to air quality problems on land (Eyring et al., 2007). These emissions can directly affect the level of acidification or the eutrophication of natural ecosystems, as well as the biodiversity of freshwater bodies due to the deposit of sulfur and nitrogen compounds. Thus, better control of NO_x, SO₂ and particle emissions can be claimed to have a beneficial impact on air quality, acidification and eutrophication (Pitts et al., 2000; Eyring et al., 2007a-b). In addition to the global impact of emissions, local and regional air quality problems in coastal areas and harbours with heavy traffic are also very important (Eyring et al., 2010). The negative effects of particles on the environment include reduced visibility (Doyle and Dorling, 2002), light scattering (Pitts and Pitts, 2000), higher rates of global warming (IPCC, 2001), accumulation on vegetation, changes to ecosystems and damage to buildings (McKenna et al., 2008). In addition, the shape of particles are of great concern due to the effects of their radiative properties. The shape of particles also has an effect upon their aerosol and optical properties in terms of attempting both satellite and ground-based remote sensing observations (Shandilya and Kumar, 2010).

The main reason for the limitation of particulate matter emissions, however, is their adverse effect on human health (Pope III, 2000; Watkinson et al., 2000; Pietropaoli et al., 2004; Pope III et al., 2004). Corbett et al. (2007) argued that particulate matter emissions from ocean-going vessels could cause approximately 60000 deaths annually from cardiopulmonary disease and lung cancer. In addition, this study also examined additional health impacts of emissions such as respiratory illnesses including bronchitis, asthma, and pneumonia. In the future, the use of low sulfur fuels may enhance air quality and prevent large-scale health impacts caused by ship emissions (Winebrake et al., 2009). Cohen et al. (2005) estimated that there are approximately 0.8 million deaths per year worldwide from outdoor urban PM_{2.5} air pollution, which accounts for 1.2% of all premature deaths each year. Fine particles are of great concern due to their ad-

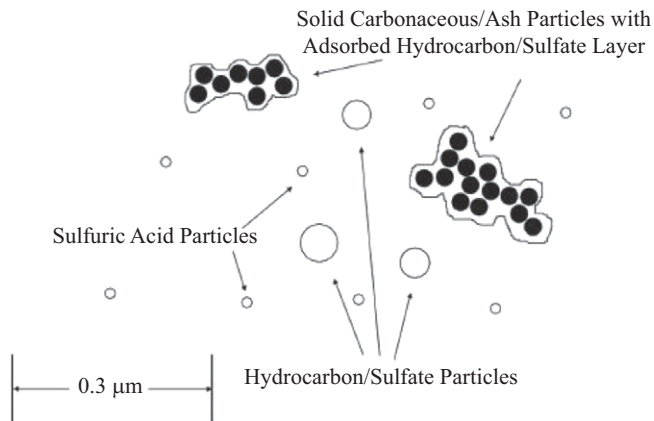

Fig. 1. Formation of diesel exhaust gas particles (Kittelson, 1998).

verse health effects, in addition to their being responsible for most of the light scattering (Pitts et al., 2000). Pope III et al. (2002) found that fine particulate and sulfur oxide-related pollution was associated with all-cause, lung cancer, and cardiopulmonary mortality. However, levels of coarse particle fraction and total suspended particles were not consistently associated with mortality rates. The health effects of PM emissions depend on the size, shape and chemical activity of the particles, as well as on personal tolerance. The smallest particles are of the greatest concern since they can penetrate the alveoli and can pass into the blood. Smaller particles follow the flow of inhaled air, but larger particles become trapped before they can reach the lungs. This is due to their aerodynamic differences. Asthmatic persons and persons with chronic obstructive pulmonary disease (COPD), as well as patients with cardiovascular diseases and young children, are mostly at risk from the adverse health effects of fine particles (Pihlava et al., 2013).

According to global estimates, ships emit between 0.9 and 1.7 million tons of particulate matter, annually (Endresen, 2003). Particulate matter emissions in the exhaust gases originate from the deposition of very small particles of partially burned fuel, partly burned lubricating oil, the ash content of fuel oil and cylinder lube oil, sulfates, and water (Heywood, 1988). The exhaust particles emitted from ships are composed of elemental, organic and inorganic carbon, sulphate and ash, as well as nitrates (Cooper, 2003; Agrawal et al., 2008). Diesel particles are usually divided into three categories: nucleation mode (10-100 nm), accumulation mode (0.1-1 μm) and coarse mode (1-10 μm). The nucleation mode is generally composed of volatile compounds, such as sulfates and unburnt hydrocarbons, it also contains ash and soot particles. Most soot particles agglomerate and are usually found in the accumulation mode, while the larger particles can be produced by the break-up of larger soot particles from the engine. Furthermore, many particles grow through the adsorption of soot, thereby leading to a complex mixture of PM (Fridell et al., 2008). Fig. 1 shows the structure of the particles.

The diesel combustion cycle is affected by engine speed, load, fuel injection timing, turbocharging, and exhaust gas recirculation.

Speed and load are the principal parameters. The overall PM emissions tend to increase with increasing load, except when idling, which can have the highest emissions (Maricq, 2007). The air/fuel ratio is the main parameter for the formation of soot particles. In addition, engine load plays a critical role in their formation (Lyyrinen, 2006). The emission of sulfate particles increases with fuel consumption, whereas the emission of soot particles and aerosols, which originate from unburned hydrocarbons, is assumed to be higher under partial loads. The emission of nitrate particles should increase with increasing combustion temperatures and loads (Winnes and Fridell, 2009).

There have been several experimental studies of ship emissions (Cooper, 2001; Agrawal et al., 2008; Moldanová et al., 2009; Agrawal et al., 2010; Winnes and Fridell, 2010; Winnes et al., 2014; Anderson et al., 2015; Shan et al., 2016). Shan et al. (2016) carried out CO₂ emission inventories by employing the apparent energy consumption approach and updated the emission factors in order to reduce the number of uncertainties. Winnes and Fridell (2009) carried out on-board emission measurements of a product tanker by using HFO and MGO under various engine loads. The effects of different fuels on the exhaust gas composition and emission factors were investigated. Kowalski (2014) examined the relationship between the exhaust emissions of marine diesel engines and the effect of fuel pump malfunctions including fuel injection timing delay and fuel leakage in one of the fuel pumps. It was found that a fuel injection timing delay causes an increase in CO₂ emissions and a decrease in NO_x emissions. CO emissions increase only under high engine loads. It was also found that fuel leakage in a fuel pump causes changes in CO emissions. In this case, fuel leakage was found to cause increased CO₂ emissions and decreased NO_x emissions. Uriondo et al. (2011) demonstrated changes in NO_x emissions between the installation condition of an engine at the factory and later under actual operating conditions during sea trials. According to the results of this study, performing emission measurements at the commissioning phase of an engine meets NO_x emission regulations. More recently, Durmaz et al. (2016) and Kalender et al. (2016) presented exhaust emission measurements from the main engine of a ferry. Zhao et al. (2015) simulated the use of the cycle mean value model approach with the calculation of engine crankshaft speed and delivered power from a container vessel. The results of the simulated fuel consumption, engine delivered power and vessel speeds were validated through the use of measured data gathered under different engine response conditions.

There have been some studies into the composition of particles emitted from ship engines. Fridell et al. (2008) reported the measurements of particle size distributions from three different ships. Cooper (2003) studied the size distribution of particles through measurements made on two ships at berth using Scanning Electron Microscopy (SEM) analysis. Wong et al. (2003) investigated the effects of different sampling techniques on the particle number, size and volume distributions under different engine loads while running on ultra-low sulfur diesel. Fuel quality, engine type, and ship activity contribute to the properties of en-

gine emissions. Lack et al. (2009) examined comprehensive data covering the physical, chemical and optical properties of PM emissions of 211 vessels in order to better understand PM characteristics in the atmosphere. Petzold et al. (2008) measured the chemical and microphysical properties of the emissions within the exhaust gas of a four-stroke marine diesel engine under different engine loads. Kasper et al. (2007) measured the particulate matter emissions from a two-stroke marine diesel engine. Agrawal et al. (2010) presented the emission factors of various gases and particulate matter, including speciated PM and hydrocarbons, of an oceangoing container vessel. Emission factors and elemental analyses have also been carried out on a crude oil tanker (Agrawal et al., 2008). Moldanová et al. (2009) reported the properties of the particles sampled in the exhaust of the main engine of a large cargo vessel. The microstructure and elemental analysis of the emissions were taken and organic carbon particles were examined by Transmission Electron Microscopy (TEM) micrographs and Energy Dispersive X-ray Spectroscopy (EDS). Chen et al. (2005) investigated the morphology, microstructure and composition of particles using different fuels by using various electron microscopy techniques. Mueller et al. (2015) studied the characteristics and temporal evolution of PM emissions from a marine diesel engine by using High Resolution Time-of-Flight Aerosol Mass Spectrometry (HR-ToF-AMS) in combination with aethalometer, particle size, online gas phase, and filter measurements. Their results showed that using fuel with a lower sulfur content reduced average PM emissions, however, engine load, and the air/fuel ratio were strongly linked to the characteristics and temporal evolution of major PM emissions. Wang et al. (2014) investigated the effects of lubricating oil additives on the character of particles from a four-cylinder turbocharged diesel engine.

The International Maritime Organization (IMO) is central to any attempts to regulate air pollution from ships. The IMO works to develop and administer new international regulations regarding different maritime topics, primarily safety, security and pollution prevention. The first rules for regulations aimed at the limitation of airborne emissions from international shipping resulted from the entry into force of Annex VI of the International Convention for the Prevention of Pollution from Ships (MARPOL) in May 2005. MARPOL was adopted in its first state in 1973 by the IMO, and the IMO MARPOL Annex VI convention regulates the emission of several pollutants, including NO_x, SO_x and CO₂ from newly built ships. Certain maritime regions are designated as emission control areas (ECAs) where the required emission levels are lower. These regulations will become gradually tighter and the number of emission control areas is expected to increase (IMO, 2009). European countries have also put into force specific measures for the reduction of ship-based air pollution in harbour areas (Entec, 2002). Turkey has also been party to MARPOL Annex VI since 2014. Although there are no specific regulations for particulate matter, globally the sulfur content of fuel will be limited to less than 0.5% from 2020, which will reduce the emissions of sulphate particles. In addition, the IMO has recently started to measure and impose

mitigation strategies on black carbon emissions due to their effects on the global climate (Di Natale and Carotenuto, 2015).

Shipping activity in the Marmara Sea has increased substantially over the last fifty years, and now it is a significant contributor to global emission totals. The Marmara Sea has both national and international marine traffic which covers transit and non-transit ships as well as domestic ships. Excluding the cargo vessel traffic, more than 2.5 million people are daily transported by sea by city ferries, sea busses and other shuttle boats crossing from one side of Istanbul to the other. Ergin (2011) calculated the exhaust emissions from ships sailing on the Marmara Sea and through the Turkish Straits by using 2010 AIS data and national statistics. A cost-benefit analysis has also been carried out for different scenarios, including one that assumed that the Marmara Sea and the Turkish Straits had been designated as an Emission Control Area. Viana et al. (2015) studied the environmental and health benefits of the Marmara Sea and the Turkish Straits being designated as an Emission Control Area, and according to their results, implementing ECA regulations would reduce ship-based PM₁₀ and PM_{2.5} ambient concentrations in Istanbul by 67% and SO₂ by 90%.

Previous studies have indicated that notable reductions in PM_{2.5} and SO₂ occur when ocean-going vessels switch from high to low sulfur fuels (Kasper et al., 2007; Khan et al., 2012). An analysis of the size distribution of particles designated as PM_{2.5} and PM₁₀ is essential to determine the health risks, as the size and chemical composition of particles are major parameters regarding their potential harm.

The aim of this study is to experimentally investigate the particulate emission characteristics of a medium speed diesel engine installed on a ferry. The study concentrated on the effects of ultra-low sulfur diesel fuel on particulate emissions. The measurements of particulate matter and gas emissions were carried out on-board a ferry operating in the Marmara Sea. The emission factors for particulate matter (PM), as well as for NO_x, SO₂, CO, CO₂ and HC are calculated and presented. The size distributions of particle mass were obtained under different engine loads. The shape and composition of particles were investigated through the use of SEM/EDX analysis.

II. EXPERIMENTAL METHODS

Emission measurements were carried out on a ferry operating in the Marmara Sea. Built in 2000, the ferry is 81 m long and has a tonnage of 1600 GRT. She has two four-stroke medium speed main engines, each delivering 883 kW power at 750 rpm. In addition, she has 3 four-stroke medium speed auxiliary engines. Table 1 presents the specifications of the main engine.

During the experimental study, the engines were operated on ultra-low sulfur diesel fuel (ULSD). Table 2 presents the fuel properties.

The emission sampling was performed in the stack of the main engine and within the engine room. The measurements were made according to IMO MARPOL Annex VI guidelines using an E2 test cycle for the main engine under different engine loads

Table 1. Specifications of the main engine.

Main Engine	
Type	4-stroke, turbocharged, intercooled
Power (kW)	883
Speed (rpm)	750
SFC (g/kWh)	198
Bore (mm)	242
Stroke (mm)	320
Swept volume (liters)	117.8
Compression ratio	12.06:1
Injection	Direct, mechanical, one pump per cylinder

Table 2. Fuel properties.

Properties	ULSD
Density (kg/m ³)	831.1
Water content (mg/kg)	48
Sulfur (mg/kg)	4.4
Cetan Index	58.6

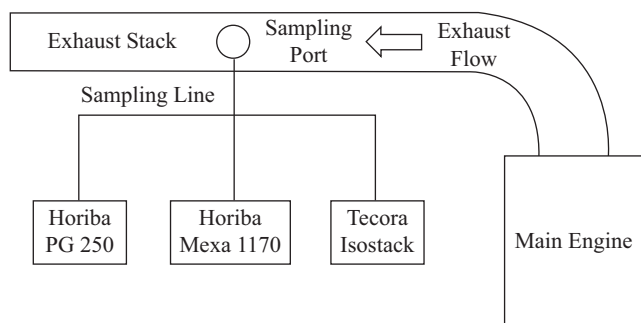
**Fig. 2. Experimental rig.**

(IMO, 2009). The sampling points were placed after the turbochargers. Fig. 2 shows the schematic for the sampling port and the sampling line for the measurements. When taking the measurements, a shaft power measurement system was continuously monitored. Shaft power, exhaust temperature, exhaust humidity and differential pressure were measured. Furthermore, ambient pressure, temperature and humidity measurements were also taken.

The measurements were taken under steady conditions, according to the E2 test cycle. Concentrations of NO_x, SO₂, CO, CO₂ and O₂ were measured in the raw exhaust gas using a Horiba PG-250 gas analyser under four different engine loads, namely 25%, 50% 75%, and 100%. Unburned hydrocarbons (HCs) were measured by a Horiba Mexa 1170. The particle measurements were taken with a Tecora Isostack Basic sampling system. 47 mm glass-microfibre filters were used to collect exhaust particles at diameters below 2.5 μm, diameters between 2.5 μm and 10 μm, and diameters above 10 μm. Sampling took around 30 minutes in as close to steady conditions as possible to ensure the isokinetic flow rate. Isokineticism requires that the

sampling flow rate must be set so that the gas velocity entering the sampling probe nozzle is equal (or as close as possible) to the gas velocity of the stack. A nozzle gas velocity lower than stack gas velocity can cause an enrichment of coarse particles in the sample because they enter the probe due to their dynamic force without following the normal laminar flow; the opposite happens when sampling at a higher nozzle gas velocity than stack gas velocity. This is why the isokinetic condition is very important, especially when a granulometric determination has to be carried out (Tecora, 2001). During the sampling, isokinetic deviation was found to be around 10%, and was therefore acceptable with regard to ISO 9096 (ISO 9096, 2003).

The filter samples were analyzed gravimetrically, and were weighed both before and after sampling by using a micro balance in the laboratory in order to obtain particle mass. The composition of the particles was investigated by SEM/EDX spectroscopy under different engine loads. The sampled filters were cut into 1 mm² pieces and were coated with a thin layer of an Au/Pd alloy. The SEM/EDX analyses were carried out with the help of a computer-controlled SEM, specifically a Jeol JSM-5410 equipped with a Philips EDX detection system.

The flow rate was calculated by using the measured exhaust velocity and exhaust pressure differences. For each engine load, engine brake power output was measured on-shaft by fixing strain gauges. Reduction gear losses were estimated at 5%.

III. RESULTS AND DISCUSSIONS

The emission measurement results for the main engine are presented as emission factors (g/kWh), and are based on the concentration of the measured exhaust pollutants, the measured engine power and the calculated exhaust flow rate. The main engine emissions of gas pollutants and particulate matters were calculated using the methodology given in the IMO NO_x Technical code E2 test cycle. The measured main engine emissions of nitrogen oxides (NO_x), sulfur dioxide (SO₂), carbon dioxide (CO₂), carbon monoxide (CO) and hydrocarbons (HC) are presented in Fig. 3, which shows that the measured NO_x emissions during experiment were between 11.0 and 16.0 g/kWh. As the emissions of NO_x mainly depend on the engine combustion temperature, the emission level of NO_x increases with engine load. However, NO_x emissions are highest under an engine load of 25% due to the leaner air/fuel mixture (EPA, 1999). CO emissions occur as a result of incomplete combustion of fuel. Mostly they increase with engine load due to the lack of oxygen. As can be seen in Fig. 3, the highest CO emission occurs under an engine load of 25% due to the low temperatures in the combustion chamber which affect fuel atomization (EPA, 2010). The emissions of CO₂ and SO₂ are related to fuel properties (Entec, 2002). However, there are some differences in the distributions within the emissions. The reason for these differences may be related to the performance of the engine under partial load, which is made worse during cold start up, as well as factors such as inadequate atomization, low combustion temperature and heat losses from the combustion chamber. In general,

Table 3. Comparison of emission factors.

Study	Vessel Type	Engine	Power (kW)	Fuel Type	Sulphur Content %	Load	SFO	Total PM (g/kWh)
This study	Ferry	ME	883	ULSD	0.0004	25	198	0.126
						50	198	0.067
						75	198	0.070
						100	198	0.090
WinnesandFridell, 2008	Tanker	ME	4500	MGO	0.03	55-60	204	0.370
			4500			70	196	0.280
			4500			85-90	191	0.380
Winnes et al., 2014	RoPax Ferry	ME	6000	MGO	0.1	57	181	N/A
	Ro-ro	ME	15800	MGO	0,1	51	174	0.050
Fridell et al., 2008	Ferry	ME	7650	MGO	0.49	41		0.330
		DG	1200	MGO	0.33	48		0.53
						73		0.4
Cooper, 2001	HS Ferry A	ME	6875	MGO	0.09	90		0.1
		DG	455	MGO	0.09	26		0.36
						46		0.28
						53		0.29
Anderson, 2015	Ferry	DF Engine	7600	LNG+ MGO		40		0.0001-0.0002
						72		0.0002-0.0004

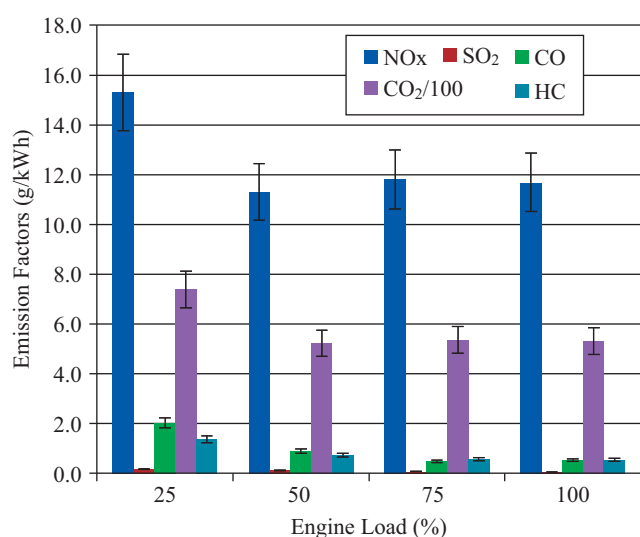
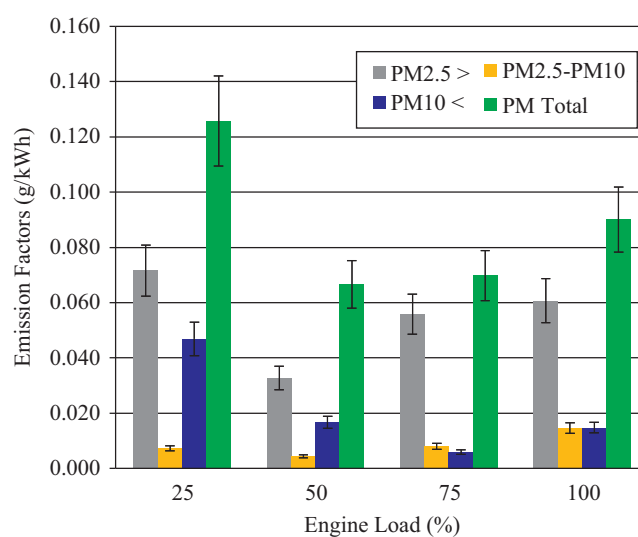
**Fig. 3. Gaseous emission factors for the main engine under different engine loads.****Fig. 4. PM emission factors for the main engine under different engine loads.**

emissions of unburned HC occur as a result of the incomplete combustion of hydrocarbon fuels (Heywood, 1988). The results show that unburned HC emissions increase under partial loads. Fig. 4 shows that the uncertainties of measurements for the gaseous emissions of the main engine are between 10-12%. The overall weighted emission factors are NO_x at 11.91 g/kWh; SO₂ at 0.10 g/kWh; CO at 0.67 g/kWh; CO₂ at 611.14 g/kWh; and HC at 0.62 g/kWh. The overall weighted NO_x emission for the main engine is 11.91 g/kWh, which is just under the limit value of 11.97 g/kWh set by the IMO MARPOL Annex VI.

Particulate matter emissions mostly depend on the sulfur content of the fuel. (Singal and Pundir, 1996; Merksiz et al., 2002;

Lyyräinen, 2006; Winnes et al., 2014). In this study, ultra-low sulfur diesel fuel was used. Therefore, the particulate emissions are quite low, as can be seen in Fig. 4. The weighted PM emission value is calculated as being 0.079 g/kWh. The highest PM emissions were observed under an engine load of 25%. This may be due to low combustion efficiencies that may influence particle formation. The rate of uncertainty regarding the PM measurement is below 13%.

The results of the emission factors for different loads are compared with the results of previous studies in Table 3. Although it is not possible to compare our results directly with the previous results, the table gives an idea regarding the emission fac-

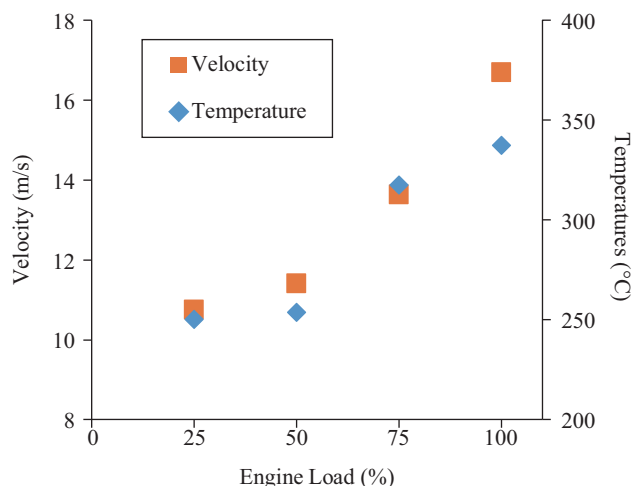

Fig. 5. Exhaust velocities and temperatures for the main engine under different engine loads.

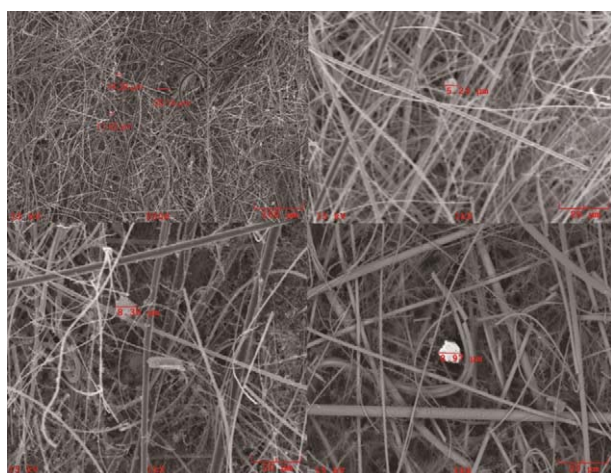

Fig. 6. Typical SEM images of total PM-deposited filters.

tors of particulate matter for different types of ship and engine using different fuel types. As can be seen in Table 3, the total PM emissions for ULSD fuel is less than the emission results for MGO.

The collection of particles was carried out for each engine load by considering their size distribution at diameters below $2.5 \mu\text{m}$ (PM_{2.5}), diameters between $2.5 \mu\text{m}$ and $10 \mu\text{m}$ (PM_{2.5}-PM₁₀) and diameters above $10 \mu\text{m}$ (PM₁₀ <). Fig. 4 shows that nuclei and accumulation mode particles, which are shown as PM_{2.5}, have the highest value under all engine loads. The value of PM_{2.5} emission factors are more than 50% of the total PM emissions under different engine loads.

Fig. 5 shows the measured exhaust velocities and temperatures for various engine loads. Particles were collected at exhaust gas temperatures between 250°C and 350°C . Due to the high exhaust temperatures, coarse particles (PM₁₀ <) can not be formed adequately (Heywood, 1988). For this reason, PM_{2.5} emission factors were high for each load. When the engine load increases, the contribution of PM_{2.5} to the total PM increases.

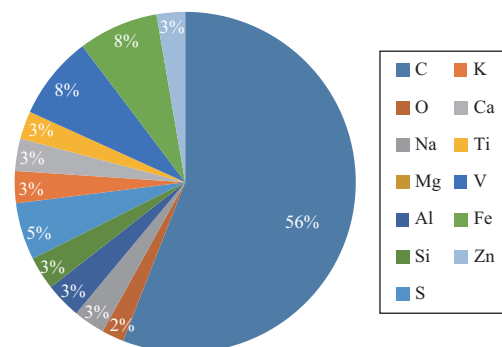

Fig. 7. Composition of particulate matter for PM_{2.5}.

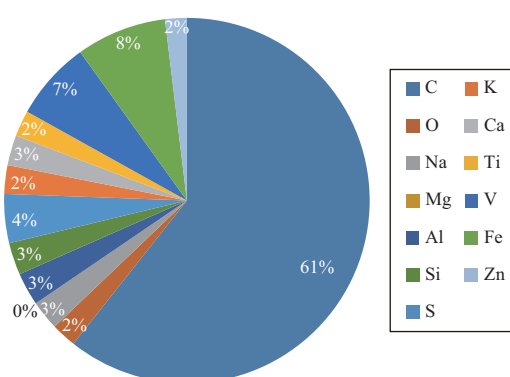

Fig. 8. Composition of particulate matter for PM₁₀ <.

With regard to the spectrum of the SEM/EDX analyses, the elemental analysis of PM were carried out and 13 elements (C, O, Na, Mg, Al, Si, S, K, Ca, Ti, V, Fe and Zn) were detected in the samples. Fig. 6 shows the images obtained by scanning electron microscopy (SEM) for the total PM absorbed filters. Various sizes of particulate matter were scaled and the shape of particles were found to be generally spherical. The particles with diameters lower than $2.5 \mu\text{m}$, could not be seen clearly on the filter due to their small size.

Figs. 7 and 8 show the composition of elements obtained by scanning electron microscopy/energy-dispersive X-ray spectroscopy (SEM/EDX) analysis. The figures show the percentage of elements for the samples PM_{2.5} and PM₁₀ <. Elemental analyses were carried out on the sample filters which were cut into 1 mm^2 pieces. Hence, the results apply only to a specific part of each filter.

The results indicate that carbon is the main component for particulate matter sizes of PM_{2.5} and PM₁₀ <. The PM_{2.5} particles consist of 56% carbon and PM₁₀ < particles consist of 61% carbon. In addition, the PM_{2.5} particles consist of 4% V and 4% Fe, whereas the PM₁₀ < particles contain 8% Fe and 7% V. Furthermore, the results show that the amount of sulfur among the total elements is quite low. This is due to the use of ultra-low sulfur content fuel. For ULSD, calcium, iron and sodium are thought to come mainly from fuel additives, since fuel additives are generally used to enhance the physical and chemical properties of diesel (Kumar et al., 2014). Trace elements

Table 4. Properties of the lubricating oil used in the main engine.

Elements	Concentration (ppm)
Fe	7.69
Cr	0.16
Al	0.87
Ni	0.02
Si	4.30
V	0
Na	0
Mg	17.7
Zn	1300
Ca	5310

such as aluminium, iron, zinc and calcium in the PM can be assumed to be generated by the combustion of the lubricating oil (Graham et al., 2010). Table 4 shows the properties of the lubricating oil used in the main engine. Typically, trace elements are detected at very low levels in the elemental analysis of ultra-low sulfur diesel. Hence, it can be assumed that trace elements, apart from carbon and sulfur, are not generated from the fuel (see, also Graham et al., 2010). On the other hand, sulfur has an important role in the self-lubricating properties of diesel. Therefore, some trace elements may result from the wear-generated metal concentrations within the engine (Heywood, 1988). As an extra point, silicon may be generated from the filter material itself.

During the elemental analysis, the filter surface elements in the sample may affect the results. Developing a method for separating the filters from any non-essential elements is of great importance with regard to obtaining more accurate results from the elemental analysis of diesel particulate matter.

IV. CONCLUSIONS

The investigation into the formation of particulate matter was carried out on-board a ferry operating in the Marmara Sea. The ship has two four-stroke medium speed diesel engines. Ultra-low sulfur diesel fuel was used during the experiment. The emission factors, size distributions and shape of particulate matter were obtained under engine loads of 25%, 50%, 75% and 100%. In addition, the elemental analysis of particles was carried out by using SEM/EDX methods. The investigation shows that the particles with diameters below 2.5 μm have the highest emission rate under all engine loads. The particles were found to be generally spherical. The elemental analysis of the particles showed that there were 13 elements in the samples. Carbon was found to be the main component of diesel particles, comprising approximately 50-60% of the total emission composition. Fe and V were found to be the most abundant detectable elements, and these comprised about 8 percent of the total emission composition. The emission factors for particulate matter (PM), as well as for NO_x, SO₂, CO, CO₂ and HC were investigated. The total weighted PM emissions was found to be quite low at 0.079 g/kWh.

Due to the ever-increasing shipping activity within the Marmara Sea, ship emissions are becoming a primary source of air pollution that should be reduced due to their adverse health and environmental impact. PM_{2.5} and PM₁₀ levels in Turkey are dramatically in excess of those stipulated by EU (European Union) and WHO (World Health Organisation) limits (EEA, 2014). In 2012, exposure to PM_{2.5} concentrations were responsible for about 432000 premature deaths originating from long-term exposure in Europe (EEA, 2015). Istanbul is the most populated city in the Marmara region, and for this reason, many people are exposed to particle emissions that can have serious effects on their health. Experimental studies and elemental analyses of particle emissions are beneficial to both anticipate and reduce the impacts of marine traffic on regional and global air quality. The characterization of these emissions may help a greater understanding of how to improve combustion efficiency. Furthermore, it will help in the development of new regulations, innovative emission reduction technologies and new mathematical models. The present paper is devoted to the evaluation of the effects of ultra-low sulphur diesel on the formation of particles. In future works, the effect of various types of fuels may be investigated to make comparisons.

ACKNOWLEDGEMENTS

The ship owner company, IDO is gratefully acknowledged for their support of the experimental study. The master, chief engineer and crew are thanked for all their kind efforts during the on-board study. We also thank the Ministry of Development and the Istanbul Development Agency for their financial support in the 'Development of an accredited laboratory to make on-board ship emissions measurements in Istanbul and IT supported training' project TR10/12/BTK/0004, which was supported under the 'Information and Communication Technologies-Oriented Economic Development Intended for Nonprofit Organizations' program.

REFERENCES

- Agrawal, H., Q. G. J. Malloy, W. A. Welch, J. W. Miller and D. R. Cocker (2008). In-use gaseous and particulate matter emissions from a modern ocean going container vessel. *Atmospheric Environment* 42(21), 5504-5510.
- Agrawal, H., W. A. Welch, S. Henningsen, J. W. Miller and D. R. Cocker (2010). Emissions from main propulsion engine on container ship at sea. *Journal of Geophysical Research: Atmospheres* (1984-2012), 115(D23).
- Agrawal, H., W. A. Welch, J. W. Miller and D. R. Cocker (2008). Emission measurements from a crude oil tanker at sea. *Environmental Science and Technology* 42(19), 7098-7103.
- Anderson, M., K. Salo and E. Fridell (2015). Particle-and gaseous emissions from an lng powered ship. *Environmental Science and Technology* 49(20), 12568-12575.
- Chen, Y., N. Shah, A. Braun, F. E. Huggins and G. P. Huffman (2005). Electron microscopy investigation of carbonaceous particulate matter generated by combustion of fossil fuels. *Energy and fuels* 19(4), 1644-1651.
- Cohen, A. J., R. Anderson, H. Ostro, B. Pandey, K. D. Krzyzanowski, M. Künzli, N. Gutschmidt, K. Pope, A. I. Romieu and J. M. Samet (2005). The global burden of disease due to outdoor air pollution. *Journal of Toxicology and Environmental Health Part A*, 68(13-14), 1301-1307.

- Cooper, D. (2001). Exhaust emissions from high speed passenger ferries. *Atmospheric Environment* 35(24), 4189-4200.
- Cooper, D. (2003). Exhaust emissions from ships at berth. *Atmospheric Environment* 37(27), 3817-3830.
- Corbett, J. J., J. J. Winebrake, E. H. Green, P. Kasibhatla, V. Eyring and A. Lauer (2007). Mortality from ship emissions: a global assessment. *Environmental Science and Technology* 41(24), 8512-8518.
- Di Natale, F. and C. Carotenuto (2015). Particulate matter in marine diesel engines exhausts: Emissions and control strategies. *Transportation Research Part D: Transport and Environment* 40, 166-191.
- Doyle, M. and S. Dorling (2002). Visibility trends in the UK 1950-1997. *Atmospheric Environment* 36(19), 3161-3172.
- Durmaz, M., S. S. Kalender and S. Ergin (2016). Bir feribottan yayılan emisyonların deneysel olarak incelenmesi, *GİDB Dergi*, Sayı:6 Yıl: 2016. (in Turkish)
- EEA. (2014). Air pollution fact sheet 2014-Turkey. Retrieved from European Environment Agency, Copenhagen, Denmark.
- EEA. (2015). Air quality in Europe-2015 report. Retrieved from European Environment Agency, Copenhagen, Denmark.
- Endresen, Ø. (2003). Emission from international sea transportation and environmental impact. *Journal of Geophysical Research*, 108(D17).
- Entec. (2002). Quantification of emissions from ships associated with ship movements between ports in the European Community. Report for the European Commission. Entec UK Limited, Northwich, Great Britain.
- EPA. (1999). Technical Bulletin, Nitrogen Oxides (NO_x), Why and How They Are Controlled. US Environmental Protection Agency Washington, DC.
- EPA. (2010). AP 42, Chapter 1: External Combustion Sources. US Environmental Protection Agency Washington, DC, Fifth Edition, I.
- Ergin, S. (2011). Controlling of Ship-Source Air Pollution, Final Report, Supported by Turkish Ministry of Environment and Urban Planning.
- Eyring, V., J. J. Corbett, D. S. Lee and J. J. Winebrake (2007a). Brief summary of the impact of ship emissions on atmospheric composition, climate and human health. Document submitted to the Health and Environment subgroup of the International Maritime Organization, 6.
- Eyring, V., D. Stevenson, A. Lauer, F. Dentener, T. Butler, W. Collins, K. Ellingsen, M. Gauss, D. Hauglustaine and I. Isaksen (2007b). Multi-model simulations of the impact of international shipping on atmospheric chemistry and climate in 2000 and 2030. *Atmospheric Chemistry and Physics* 7(3), 757-780.
- Eyring, V., I. S. A. Isaksen, T. Berntsen, W. J. Collins, J. J. Corbett, O. Endresen, R. G. Grainger, J. Moldanova, H. Schlager and D. S. Stevenson (2010). Transport impacts on atmosphere and climate: Shipping. *Atmospheric Environment* 44 (37), 4735-4771.
- Fridell, E., E. Steen and K. Peterson (2008). Primary particles in ship emissions. *Atmospheric Environment* 42(6), 1160-1168.
- Graham, J., L. Shields, P. Miller and A. Marin (2010). Determination of Sulfur and Toxic Metals Content of Distillates and Residual Oil in the State of New York, Final Report.
- Heywood, J. B. (1988). *Internal combustion engine fundamentals* (Vol. 930): McGraw-hill New York.
- IMO. (2009). Revised MARPOL Annex VI: Regulations for the Prevention of Air Pollution from Ships and NO_x Technical Code 2008: International Maritime Organization.
- IPCC. (2001). Synthesis Report. A Contribution of Working Groups I, II, III to the Third Assessment Report of the Intergovernmental Panel on Climate Change: Cambridge University Press: Cambridge, UK.
- ISO9096. (2003). International Standards Organisation, ISO 9096, Stationary Source Emissions—Determination of concentration and mass flow rate of particulate material in gas-carrying ducts
- Kalender, S. S., M. Durmaz, S. Ergin (2016). On-board measurements of emissions from a ferry, Proc. of the 3rd Int. Conf. on Maritime Technology and Engineering, MARTECH 2016, 4-6 July 2016, Lisbon, Portugal 745-749 Volume 2, ISBN 978-1-138-03000-8.
- Kasper, A., S. Aufdenblatten, A. Forss, M. Mohr and H. Burtscher (2007). Particulate Emissions from a low-speed marine diesel engine. *Aerosol Science and Technology* 41(1), 24-32.
- Khan, M. Y., M. Giordano, J. Gutierrez, W. A. Welch, A. Asa-Awuku, J. W. Miller and D. R. Cocker III (2012). Benefits of two mitigation strategies for container vessels: cleaner engines and cleaner fuels. *Environmental Science and Technology* 46(9), 5049-5056.
- Kittelson, D. B. (1998). Engines and nanoparticles: a review. *Journal of Aerosol Science* 29(5), 575-588.
- Kowalski, J. (2014). An experimental study of emission and combustion characteristics of marine diesel engine with fuel pump malfunctions. *Applied Thermal Engineering* 65(1), 469-476.
- Kumar, A., D.-S. Kim, H. Omidvarborna and S. K. Kuppili (2014). Combustion Chemistry of Biodiesel for Use in Urban Transport Buses: Experiment and Modeling No. CA-MNTRC-14-1146.
- Lack, D. A., J. J. Corbett, T. Onasch, B. Lerner, P. Massoli, P. K. Quinn, T. S. Bates, D. S. Covert, D. Coffman, B. Sierau, S. Herndon, J. Allan, T. Baynard, E. Lovejoy, A. R. Ravishankara and E. Williams (2009). Particulate emissions from commercial shipping: Chemical, physical, and optical properties. *Journal of Geophysical Research* 114, D00F04.
- Lyyräinen, J. (2006). Particle formation, deposition and particle induced corrosion in large-scale medium-speed diesel engines: VTT Technical Research Centre of Finland.
- Maricq, M. M. (2007). Chemical characterization of particulate emissions from diesel engines: A review. *Journal of Aerosol Science*, 38(11), 1079-1118.
- McKenna, J. D., J. H. Turner and J. P. McKenna Jr. (2008). Fine particle (2.5 microns) emissions: regulations, measurement, and control: John Wiley and Sons.
- Merkisz, J., M. Kozak, P. Bielaczyc and A. Szczotka (2002). An investigation of influence of diesel fuel sulphur content on particulates emissions from direct injection common rail diesel vehicle. *Journal of KONES Internal Combustion Engines* (3-4).
- Moldanová, J., E. Fridell, O. Popovicheva, B. Demirdjian, V. Tishkova, A. Faccineto and C. Focsa (2009). Characterisation of particulate matter and gaseous emissions from a large ship diesel engine. *Atmospheric Environment* 43(16), 2632-2641.
- Mueller, L., G. Jakobi, H. Czech, B. Stengel, J. Orasche, J. M. Arteaga-Salas, E. Karg, M. Elsasser, O. Sippula and T. Streibel (2015). Characteristics and temporal evolution of particulate emissions from a ship diesel engine. *Applied Energy* 155, 204-217.
- Petzold, A., J. Hasselbach, P. Lauer, R. Baumann, K. Franke, C. Gurk, H. Schlager and E. Weingartner (2008). Experimental studies on particle emissions from cruising ship, their characteristic properties, transformation and atmospheric lifetime in the marine boundary layer. *Atmospheric Chemistry and Physics* 8(9), 2387-2403.
- Pietropaoli, A. P., M. W. Frampton, R. W. Hyde, P. E. Morrow, G. Oberdörster, C. Cox, D. M. Speers, L. M. Frasier, D. C. Chalupa and L.-S. Huang (2004). Pulmonary function, diffusing capacity, and inflammation in healthy and asthmatic subjects exposed to ultrafine particles. *Inhalation toxicology* 16 (sup1), 59-72.
- Pihlava, T., M. Uuppo and S. Niemi (2013). Health effects of exhaust particles. Paper presented at the In Proceedings of the University of Vaasa, Reports Vaasa, Finland.
- Pitts, B. F. and J. Pitts (2000). *Chemistry of the upper and lower atmosphere: Theory, experiments and applications*: Academic Press New York.
- Pope III, C. (2000). Epidemiology of fine particulate air pollution and human health: biologic mechanisms and who's at risk? *Environmental health perspectives*, 108(Suppl 4), 713.
- Pope III, C., R. T. Burnett, M. J. Thun, E. E. Calle, D. Krewski, K. Ito and G. D. Thurston (2002). Lung cancer, cardiopulmonary mortality, and long-term exposure to fine particulate air pollution. *JAMA* 287(9), 1132-1141.
- Pope III, C., R. T. Burnett, G. D. Thurston, M. J. Thun, E. E. Calle, D. Krewski and J. J. Godleski (2004). Cardiovascular mortality and long-term exposure to particulate air pollution epidemiological evidence of general pathophysiological pathways of disease. *Circulation* 109(1), 71-77.
- Shan, Y., J. Liu, Z. Liu, X. Xu, S. Shao, P. Wang and D. Guan (2016). New provincial CO₂ emission inventories in China based on apparent energy consumption data and updated emission factors. *Applied Energy* in press.
- Shandilya, K. K. and A. Kumar (2010). Qualitative evaluation of particulate

- matter inside public transit buses operated by biodiesel. *Open Environmental Engineering Journal* 3, 13-20.
- Singal, S. and B. Pundir (1996). Diesel fuel quality and particulate emissions: an overview (0148-7191). Retrieved from SAE Technical Paper
- Tecora. (2001). Tecora Isostack Basic User Manual Rev. 0.3 Eng.
- Uriondo, Z., C. V. D. Grados, M. Clemente, J. M. Gutiérrez and L. Martín (2011). Effects of charged air temperature and pressure on NOx emissions of marine medium speed engines. *Transportation Research Part D: Transport and Environment* 16(4), 288-295.
- Viana, M., N. Fann, A. Tobias, X. Querol, D. Rojas-Rueda, A. Plaza, G. Aynos, J. Conde, L. Fernández and C. Fernández (2015). Environmental and health benefits from designating the marmara sea and the Turkish Straits as an Emission Control Area (ECA). *Environmental Science and Technology* 49(6), 3304-3313.
- Wang, Y., X. Liang, G. Shu, X. Wang, X. Sun and C. Liu (2014). Effect of lubricant oil additive on size distribution, morphology, and nanostructure of diesel particulate matter. *Applied Energy* 130, 33-40.
- Watkinson, W., M. Campen, J. Nolan, U. Kodavanti, K. Dreher, W. Su, J. Highfill and D. Costa (2000). Cardiovascular effects following exposure to particulate matter in healthy and cardiopulmonary-compromised rats. Relationships between acute and chronic effects of air pollution Heinrich, U. and Mohr, U.(eds) 447-463.
- Winebrake, J., J. Corbett, E. Green, A. Lauer and V. Eyring (2009). Mitigating the health impacts of pollution from oceangoing shipping: an assessment of low-sulfur fuel mandates. *Environmental Science and Technology* 43(13), 4776-4782.
- Winnes, H. and E. Fridell (2009). Particle emissions from ships: Dependence on fuel type. *Journal of the Air and Waste Management Association* 59(12), 1391-1398.
- Winnes, H. and E. Fridell (2010). Emissions of NOx and particles from manoeuvring ships. *Transportation Research Part D: Transport and Environment* 15(4), 204-211.
- Winnes, H., J. Moldanova, M. Anderson and E. Fridell (2014). On-board measurements of particle emissions from marine engines using fuels with different sulphur content. *Proceedings of the Institution of Mechanical Engineers, Part M: Journal of Engineering for the Maritime Environment*.
- Wong, C. P., T. L. Chan and C. W. Leung (2003). Characterisation of diesel exhaust particle number and size distributions using mini-dilution tunnel and ejector-diluter measurement techniques. *Atmospheric Environment* 37(31), 4435-4446.
- Zhao, F., W. Yang, W. W. Tan, S. K. Chou and W. Yu (2015). An Overall Ship Propulsion Model for Fuel Efficiency Study. *Energy Procedia* 75, 813-818.